

Modular check valves type HR, KR, JPR

direct or pilot operated, ISO 4401 sizes 06, 10, 16 and 25

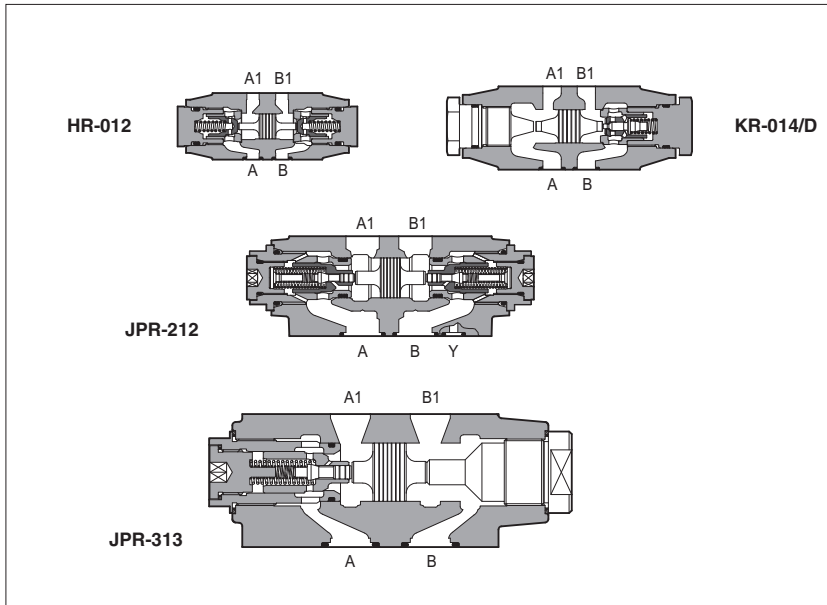

HR, KR are check valves available as direct or pilot operated models. JPR are pilot operated check valves.

Optional versions with decompression are available on request for some models of KR.

HR-0 = ISO 4401 size 06 interface: flow up to 60 l/min, pressure up to 350 bar.

KR-0 = ISO 4401 size 10 interface: flow up to 120 l/min, pressure up to 315 bar.

JPR-2 = ISO 4401 size 16 interface: flow up to 200 l/min, pressure up to 350 bar.

JPR-3 = ISO 4401 size 25 interface: flow up to 300 l/min, pressure up to 350 bar.

Valves are designed to operate in hydraulic systems with hydraulic mineral oil or synthetic fluid having similar lubricating characteristics.

1 MODEL CODE

HR-0	12	/4	*	**	/*
Modular check valve, size: HR-0 = 06 KR-0 = 10 JPR-2 = 16 JPR-3 = 25				Seals material: omit for NBR (mineral oil & water glycol) PE = FPM	
Configuration, see section 2 direct operated (not available for JPR): 02 = double, acting on port A and B 03 = single, acting on port A 04 = single, acting on port B 11 = single, acting on port P 16 = single, acting on port T				Series number	
pilot operated: 12 = double, acting on port A and B 13 = single, acting on port A 14 = single, acting on port B		Options (only for KR-012, -013, -014): /D = with decompression (only with cracking pressure standard = 1 bar)		Spring cracking pressure for HR and KR - = 0,5 bar (std.) /2 = 2 bar	
		for JPR - = 0,5 bar			

2 VALVE CONFIGURATION

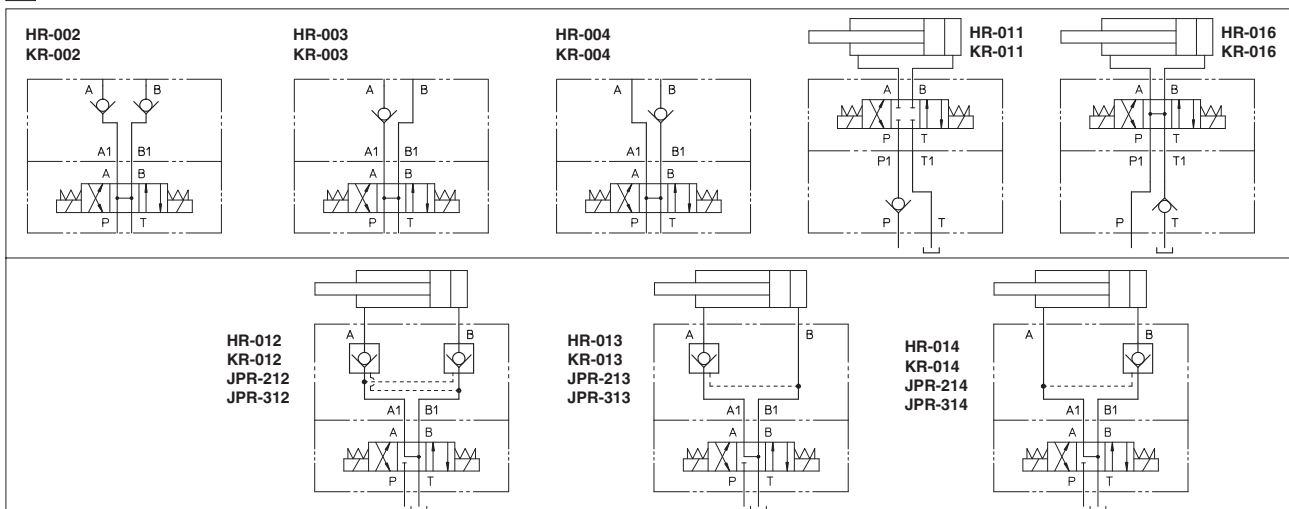

The pilot pressure applied through ports A or B opens the valve acting on ports B and A, respectively. The minimum pilot pressure is a function of the area ratio, see the following table.

VALVE TYPE	AREA RATIO
HR	3,3:1
KR	3,3:1 (standard); 11:1 (option /D decompression system)
JPR-2	13,6:1 (standard version equipped with decompression system)
JPR-3	17:1 (standard version equipped with decompression system)

3 MAIN CHARACTERISTICS OF MODULAR CHECK VALVES TYPE HR, KR, JPR

Assembly position	Any position
Subplate surface finishing	Roughness index Ra 0,4 - flatness ratio 0,01/100 (ISO 1101)
Ambient temperature	-20°C to + 70°C
Fluid	Hydraulic oil as per DIN 51524...535, for other fluids see section I
Recommended viscosity	15 ÷ 100 mm ² /s at 40°C (ISO VG 15 ÷ 100)
Fluid contamination class	ISO 4401 class 21/19/16 NAS 1638 class 10 (filters at 25 µm value with β ₂₅ ≥ 75 recommended)
Fluid temperature	-20°C +60°C (standard seals and water glycol) -20°C +80°C (/PE seals)

4 DIAGRAMS OF HR-0 based on mineral oil ISO VG 46 at 50°C

Flow through check valve:

- 1 = A→A₁; B→B₁ of HR-012, HR-013, HR-014
- 2 = A₁→A; B₁→B of HR-012, HR-013, HR-014
- 3 = HR-011, HR-016

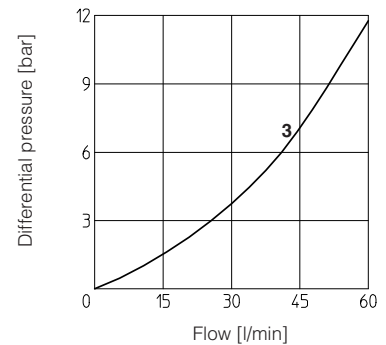
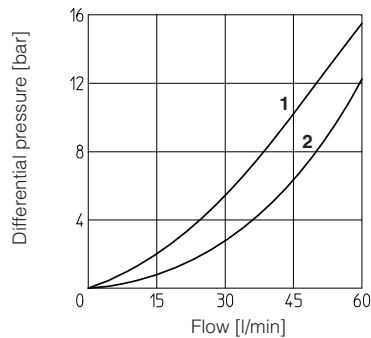

5 DIAGRAMS OF KR-0 based on mineral oil ISO VG 46 at 50°C

Flow through check valve:

- 1 = A→A₁; B→B₁ of KR-012, KR-013, KR-014
- 2 = A₁→A; B₁→B of KR-012, KR-013, KR-014
- 3 = KR-011, KR-016

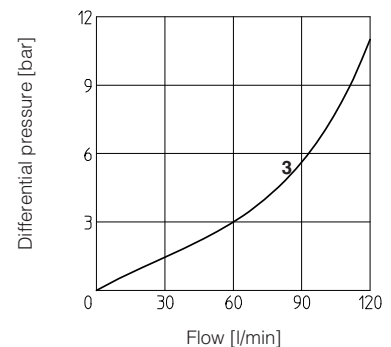
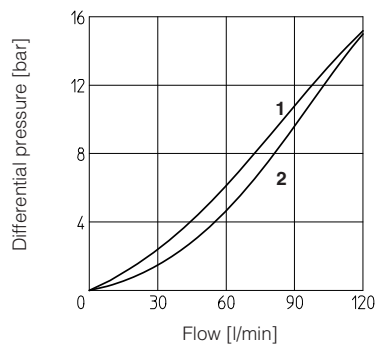

6 DIAGRAMS OF JPR-2 based on mineral oil ISO VG 46 at 50°C

Flow through check valve:

- 1 = A→A₁; B→B₁ of JPR-212, JPR-213, JPR-214
- 2 = A₁→A; B₁→B of JPR-212, JPR-213, JPR-214

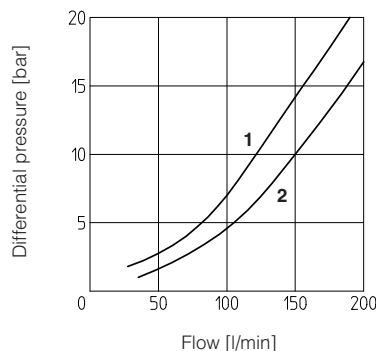

7 DIAGRAMS OF JPR-3 based on mineral oil ISO VG 46 at 50°C

Flow through check valve:

- 1 = A→A₁; B→B₁ of JPR-312, JPR-313, JPR-314
- 2 = A₁→A; B₁→B of JPR-312, JPR-313, JPR-314

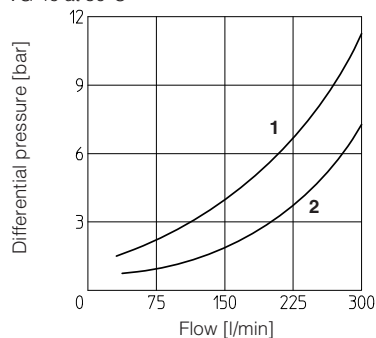

8 INSTALLATION DIMENSIONS OF HR-0 VALVES [mm]

HR-002
HR-003
HR-004
HR-012
HR-013
HR-014

LATERAL VIEW

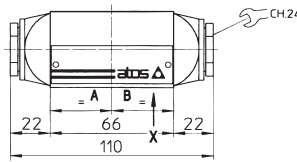
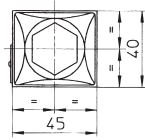

Mass: 1 Kg

HR-011
HR-016

LATERAL VIEW

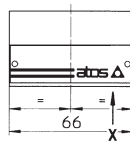
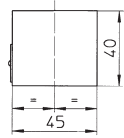

Mass: 0,7 Kg

ISO 4401: 2005

Mounting surface: 4401-03-02-0-05

Diameter of ports A, B, P, T: $\varnothing = 7,5$ mm (max)

Seals: 4 OR 108

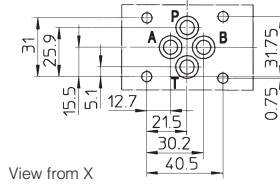

View from X

Fastening bolts: n° 4 socket head screws M5. The length depends on number and type of modular elements associated.

9 INSTALLATION DIMENSIONS OF KR-0 VALVES [mm]

KR-012
KR-002
KR-003
KR-004
KR-013
KR-014

LATERAL VIEW

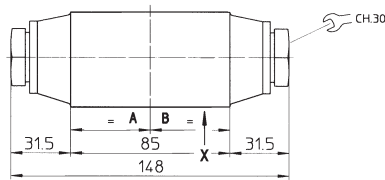
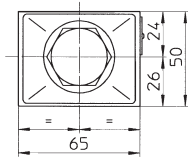

Massa: 2,3 Kg

KR-016

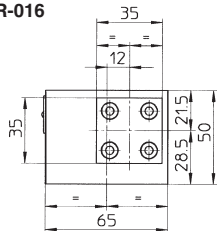

Mass: 2,5 Kg

LATERAL VIEW

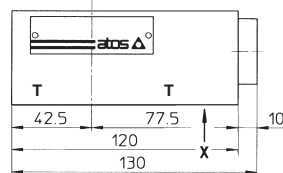

KR-011

LATERAL VIEW

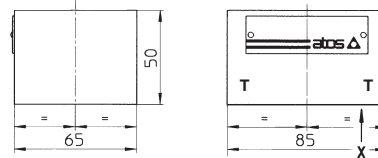

Mass: 1,7 Kg

ISO 4401: 2005

Mounting surface: 4401-05-04-0-05

Diameter of ports, A, B, P, T: $\varnothing = 11,2$ mm (max)

Seals: 5 OR 2050

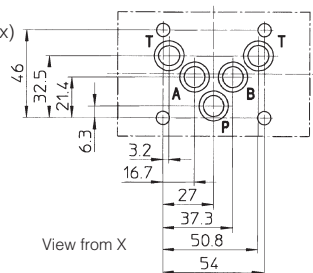

View from X

Fastening bolts: n° 4 socket head screws M6. The length depends on number and type of modular elements associated.

10 INSTALLATION DIMENSIONS OF JPR-2 VALVES [mm]

JPR-212
JPR-213
JPR-214

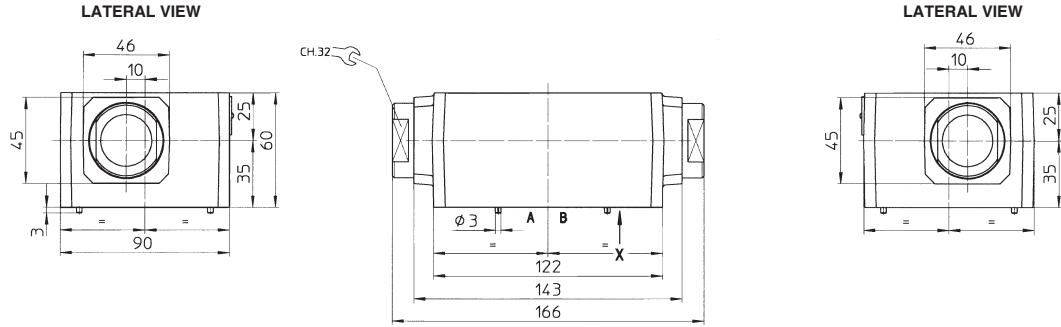

Mass: 4,4 Kg

ISO 4401: 2005

Mounting surface: 4401-07-07-0-05

Diameter of ports A, B, P, T: $\varnothing = 20$ mm

Diameter of ports X, Y: $\varnothing = 7$ mm

Seals: 4 OR 130; 2 OR 109

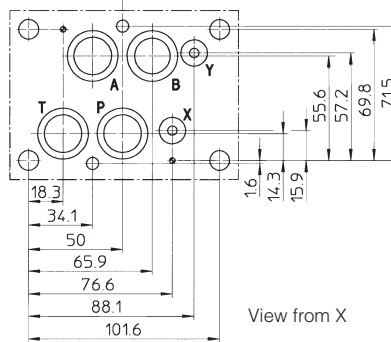

View from X

Fastening bolts: n° 4 socket head screws M10 and n° 2 M6. The length depends on number and type of modular elements associated.

11 INSTALLATION DIMENSIONS OF JPR-3 VALVES [mm]

JPR-312
JPR-313
JPR-314

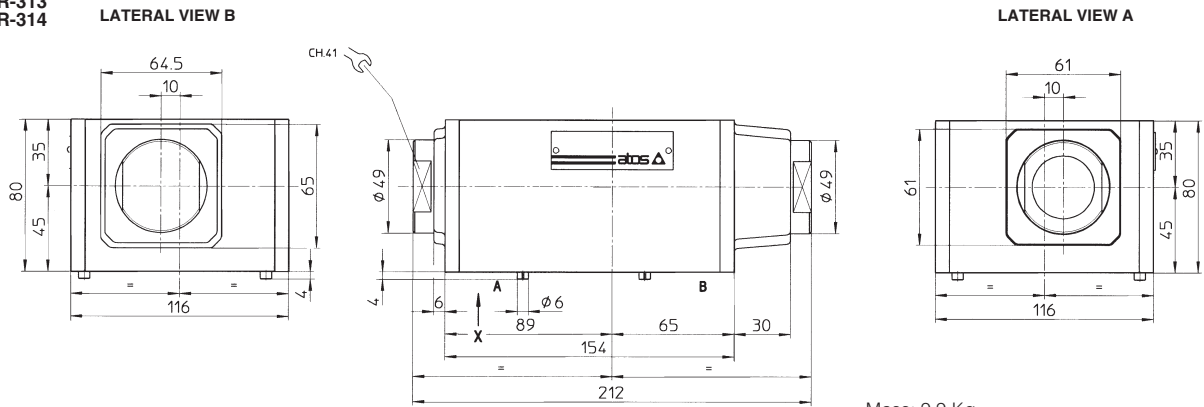

Mass: 9,9 Kg

ISO 4401: 2005

Mounting surface: 4401-08-08-0-05

Diameter of ports A, B, P, T: $\varnothing = 24$ mm

Diameter of ports X, Y: $\varnothing = 7$ mm

Seals: 4 OR 4112; 2 OR 3056

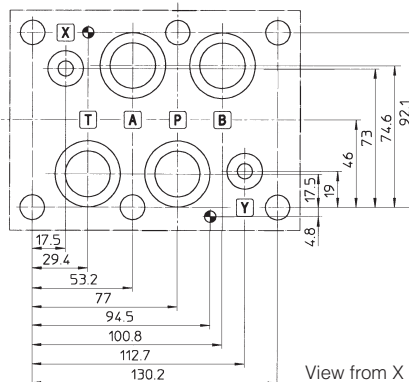

View from X

Fastening bolts: n° 6 socket head screws M12. The length depends on number and type of modular elements associated.